



# New CSC computing resources

**Juha Fagerholm, Tomasz Malkiewicz, Tommi Tervo and Jan Åström,  
CSC – IT Center for Science Ltd.**

# Outline

- CSC at glance
- New Kajaani Data Centre
- Finland's new supercomputers
  - *Sisu* (Cray XC30)
  - *Taito* (HP cluster)
- CSC resources available for researchers



# CSC's Services

- FUNET Services
- Computing Services
- Application Services
- Data Services for Science and Culture
- Information Management Services

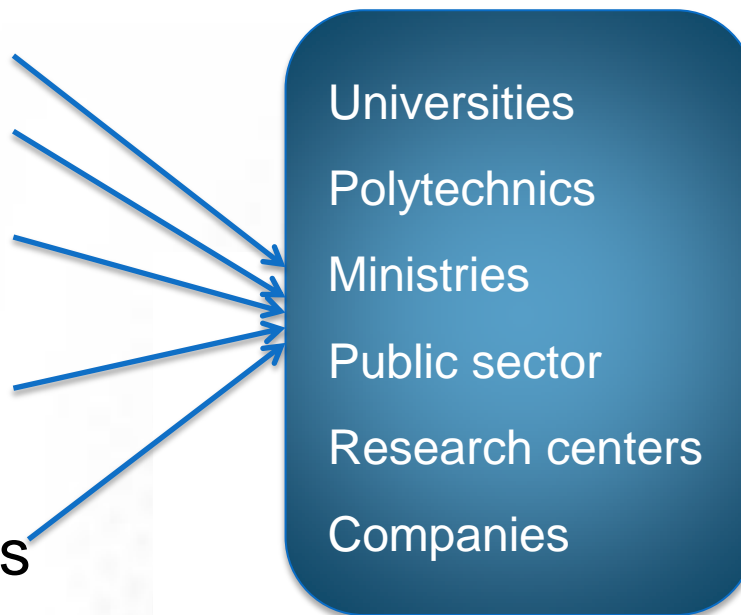

# CSC at glance



- Founded in 1971
  - technical support unit for Univac 1108
- Connected Finland to Internet in 1988
- Reorganized as a company, CSC – Scientific Computing Ltd. in 1993
- All shares to the Ministry of Education and Culture of Finland in 1997
- Operates on a *non-profit* principle
- Facilities in Espoo and Kajaani
- Staff ~250 people
- Turnover 2011 27.3 million euros



# Users



- About 700 active computing projects
  - 3000 researchers use CSC's computing capacity
  - 4250 registered customers
- Haka-identity federation covers 99% of universities and higher education institutes (287 000 users)
- Funet - Finnish research and education network
  - Total of 360 000 end users



# Users of computing resources by discipline 3Q/2012 (total 1305 users)

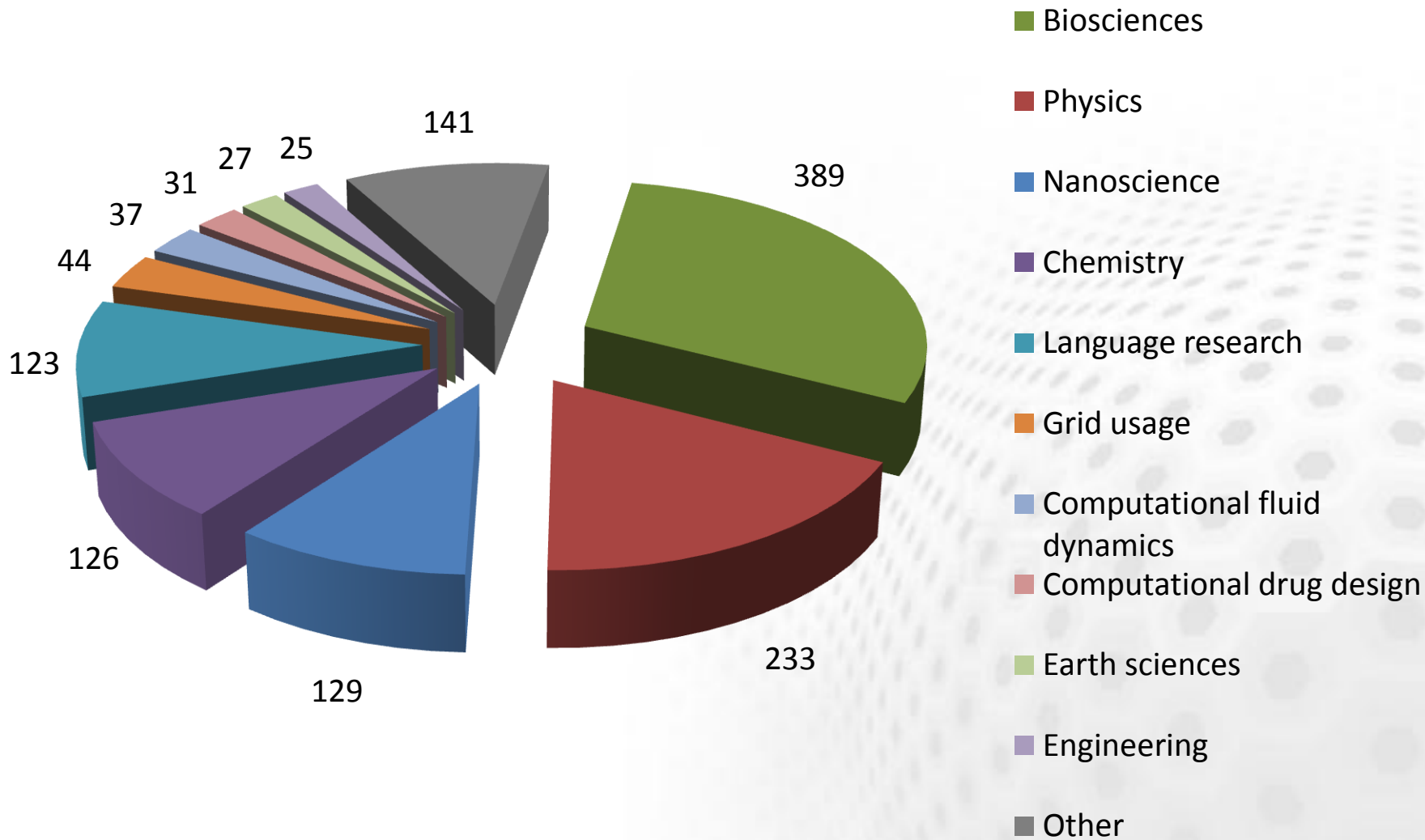

# Usage of processor time by discipline 3Q/2012 (total 2012 96 million cpuh)

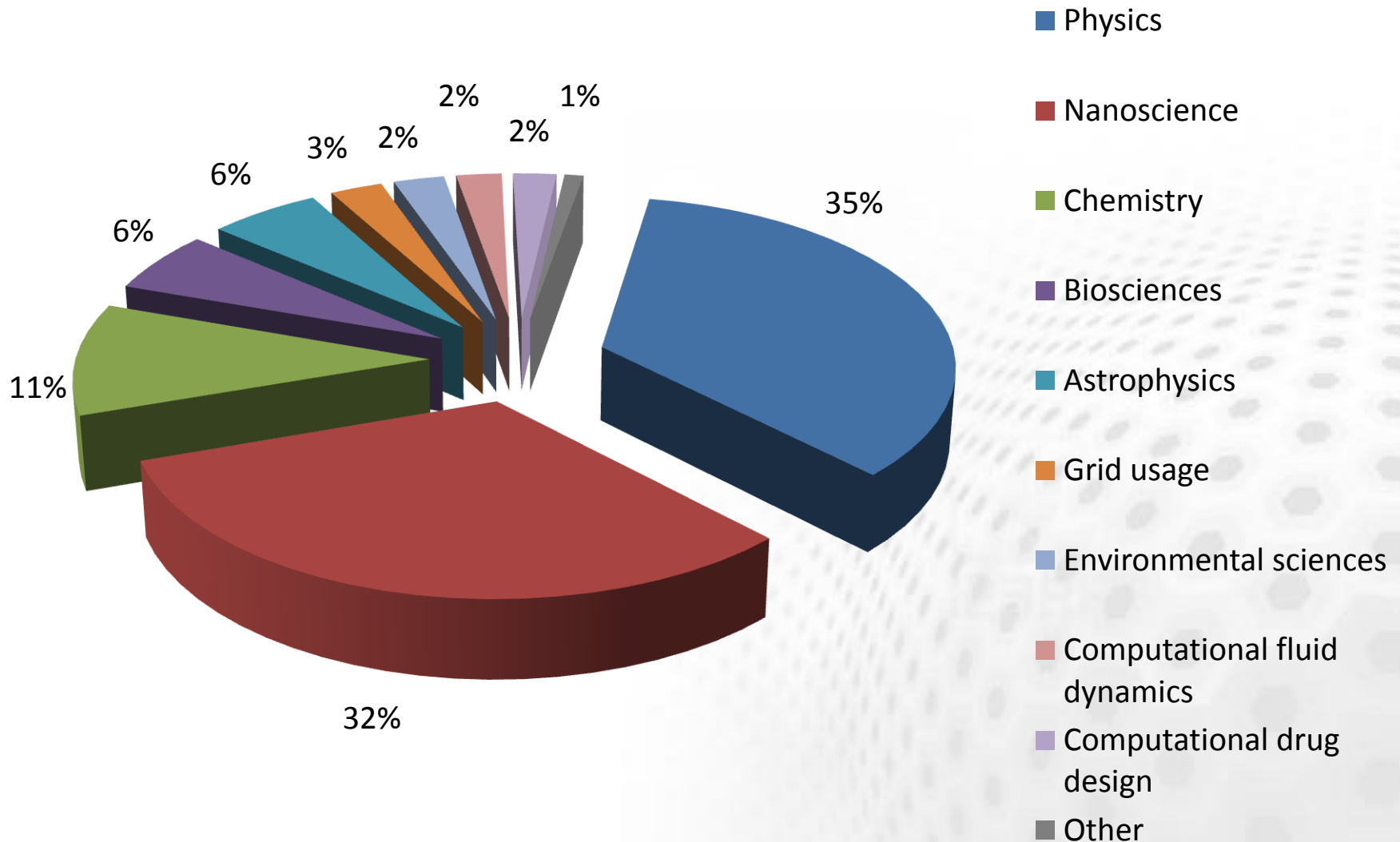

# Usage of processor time by organization 3Q/2012 (total 2012 96 million cpuh)

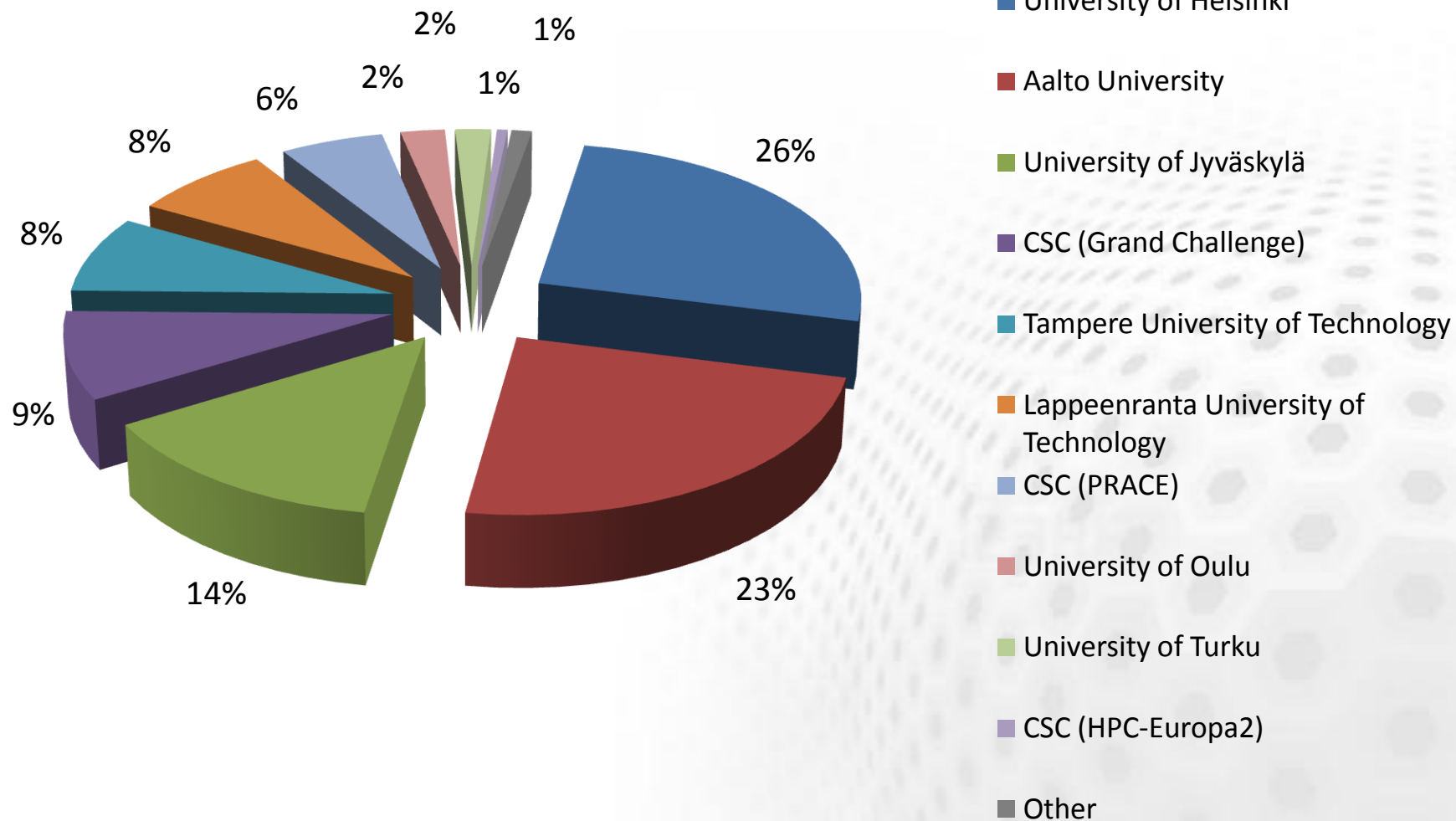



# FUNET and Data services



## FUNET

- Connections to all higher education institutions in Finland and for 37 state research institutes and other organizations
- Network Services and Light paths
- Network Security – Funet CERT
- eduroam – wireless network roaming
- Haka-identity Management
- Campus Support
- The NORDUnet network

## Data services

- Digital Preservation and Data for Research
  - Data for Research (TTA), National Digital Library (KDK)
  - International collaboration via EU projects (EUDAT, APARSEN, ODE, SIM4RDM)
- Database and information services
  - Paituli: GIS service
  - Nic.funet.fi – freely distributable files with FTP since 1990
  - CSC Stream
  - Database administration services
- Memory organizations (Finnish university and polytechnics libraries, Finnish National Audiovisual Archive, Finnish National Archives, Finnish National Gallery)

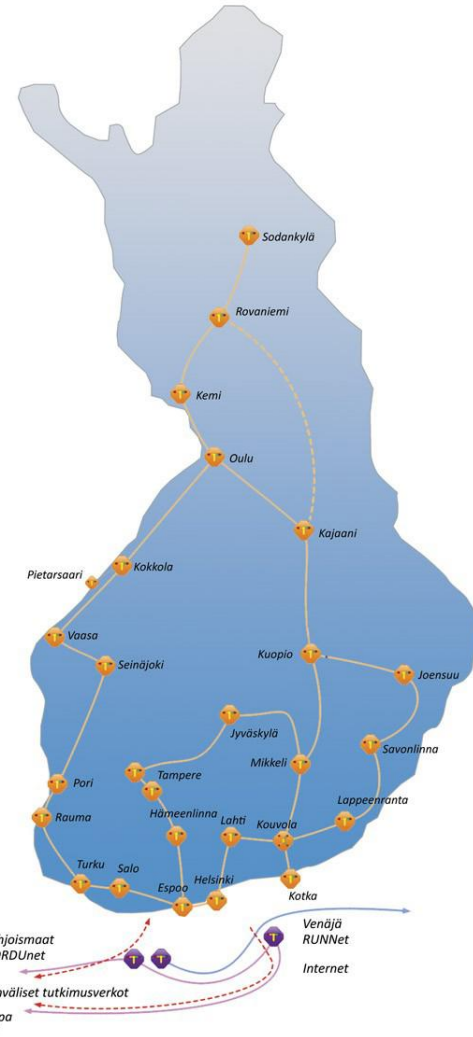

# CSC and High Performance Computing



# CSC Computing Capacity 1989–2012

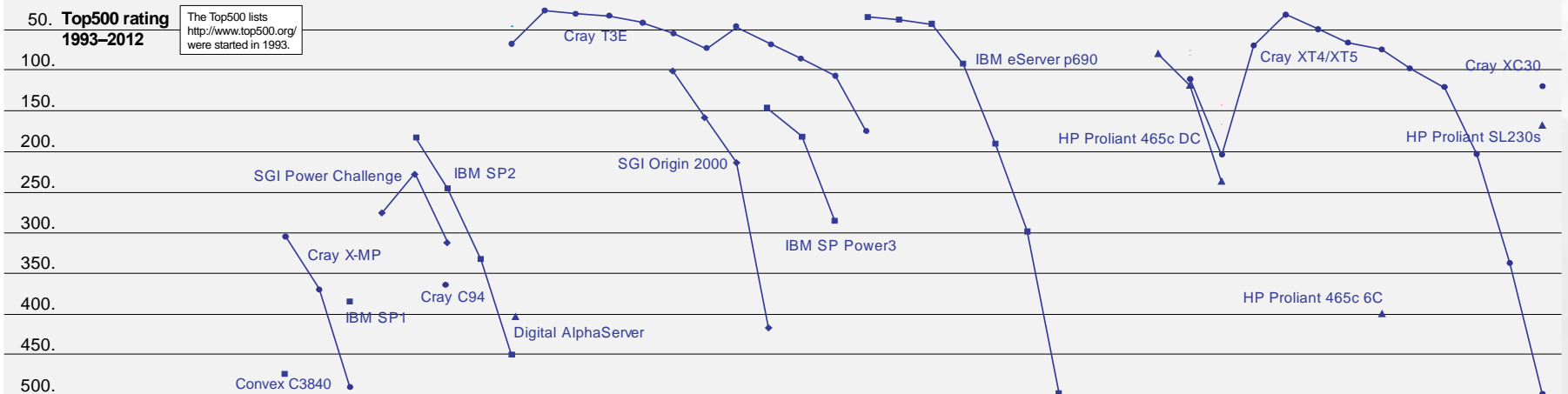
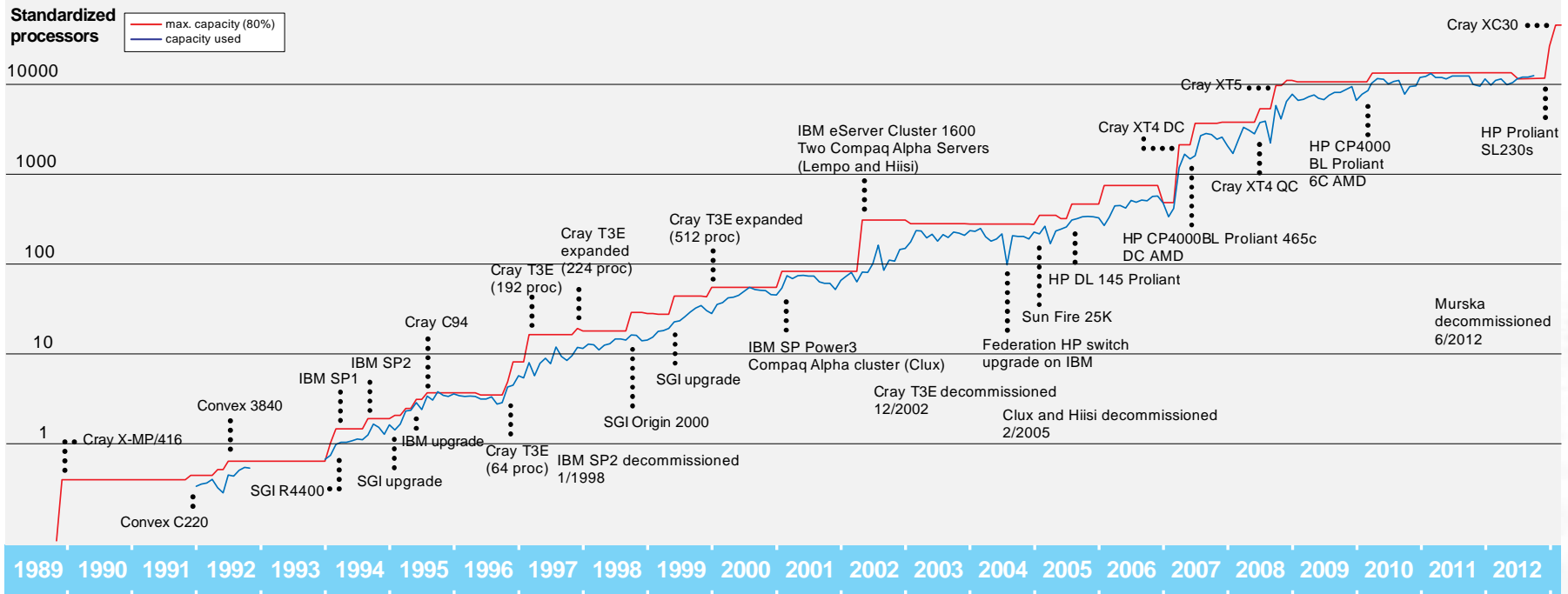

# THE NEW DATACENTER

# KMDC - Kajaani modular datacenter

*DC1 2005 (500kW/ 1.62 PUE)  
DC 2 2008 (800kW/1.38 PUE)  
DC 3 2012 (xMW/1.2 PUE)*



**Vision 2015**  
**CSC – Pioneer in the Sustainable Development of ICT Services**



# Estimate of Water-side Economizer Hours For Data Centers

© 2009 The Green Grid

Number of Available Hours Where:  
Wet Bulb Temperature  $\leq$  50F (10C)

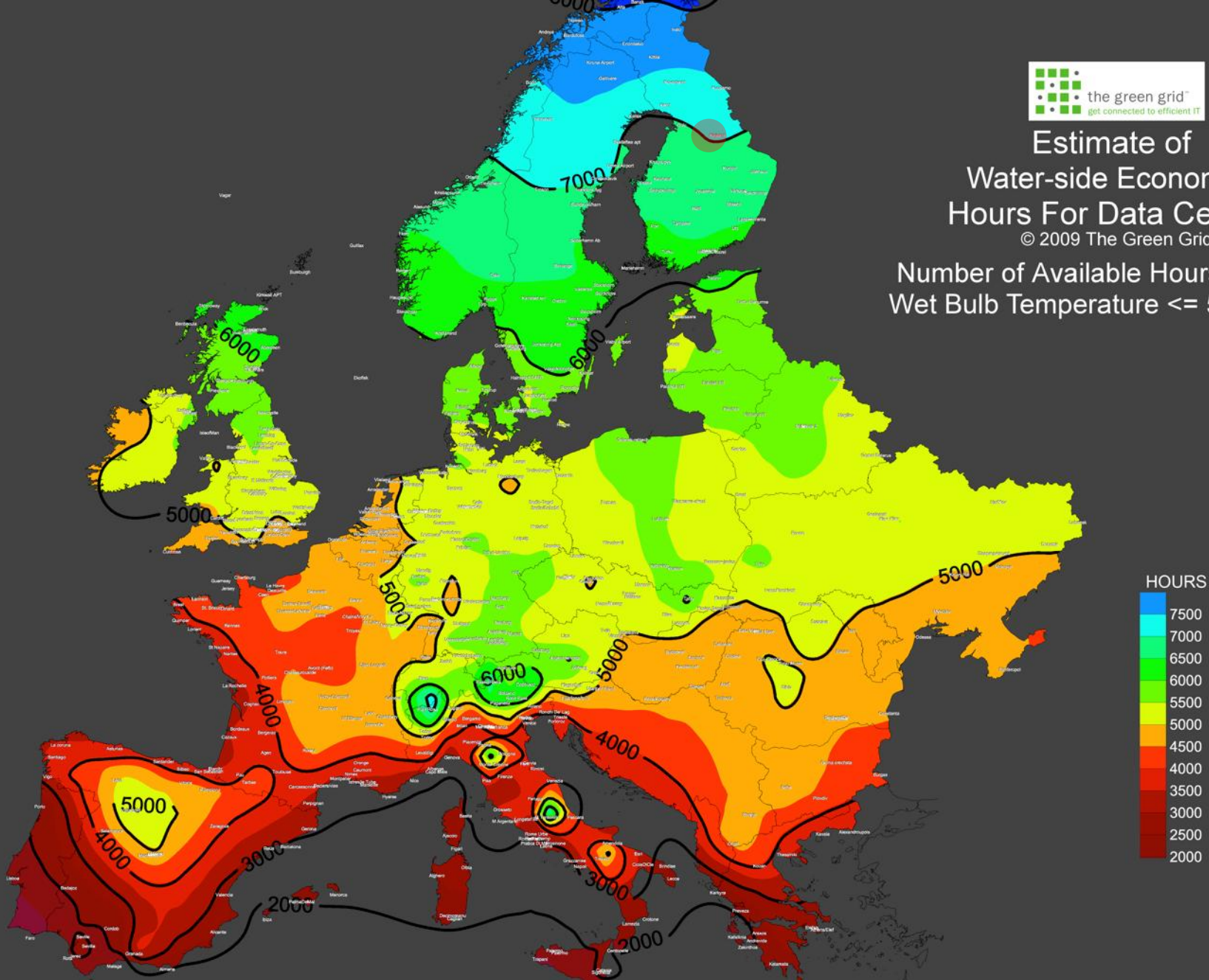

# Power distribution (FinGrid)

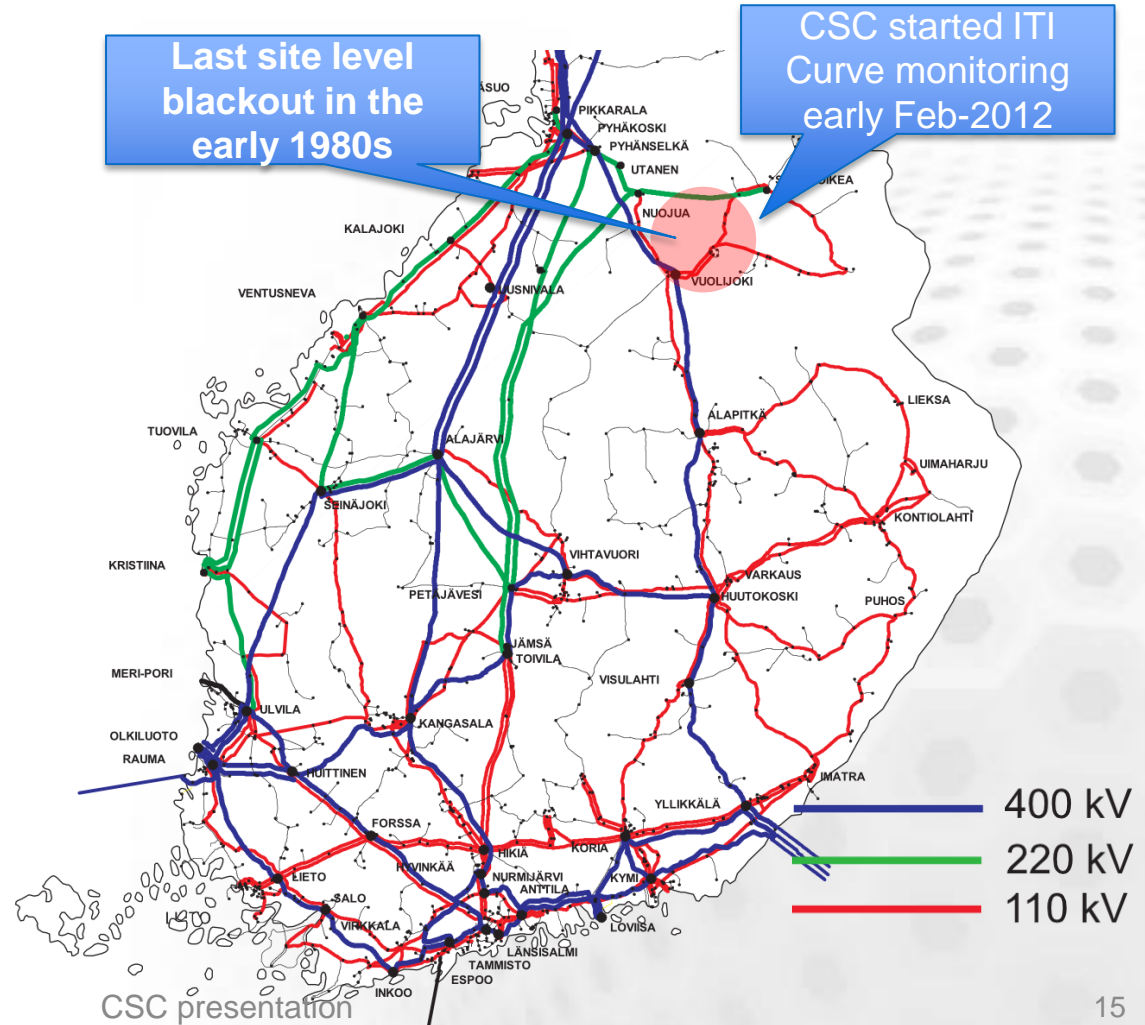
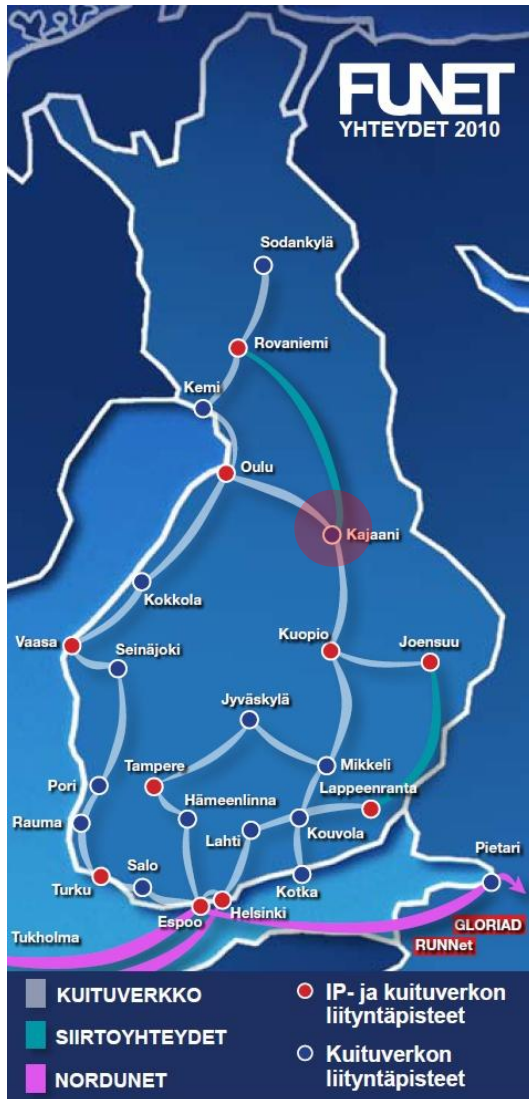

# The machine hall





# Sisu (Cray) supercomputer housing

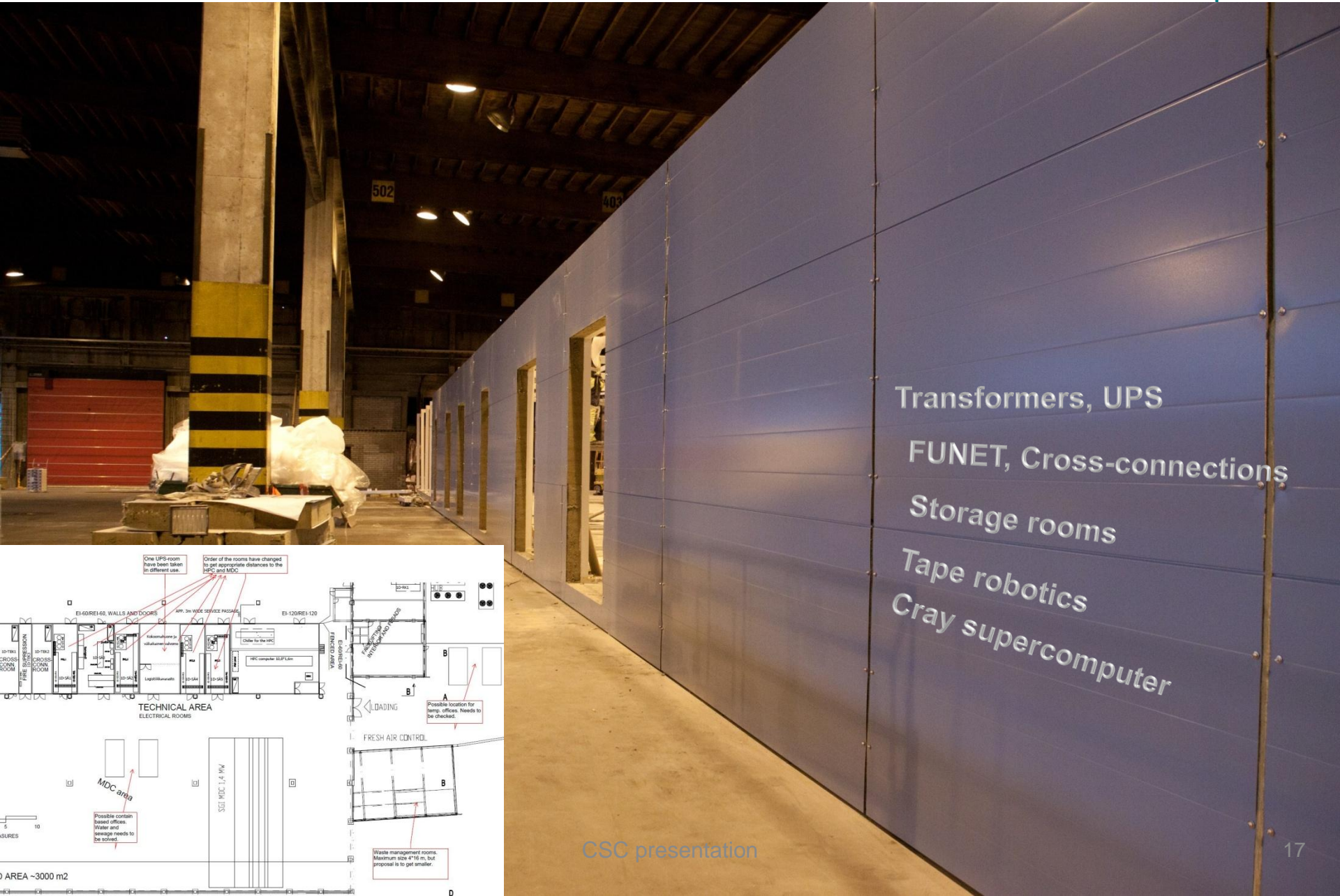

Transformers, UPS

FUNET, Cross-connections

Storage rooms

Tape robotics

Cray supercomputer

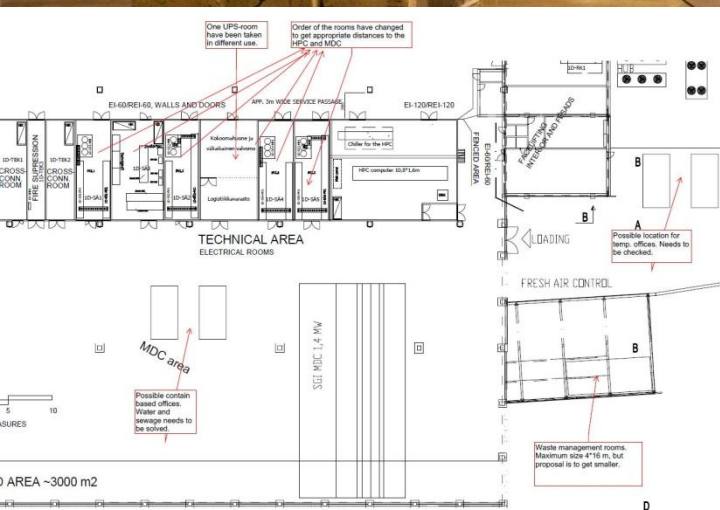



# SGI Ice Cube R80, hosting Taito (HP)

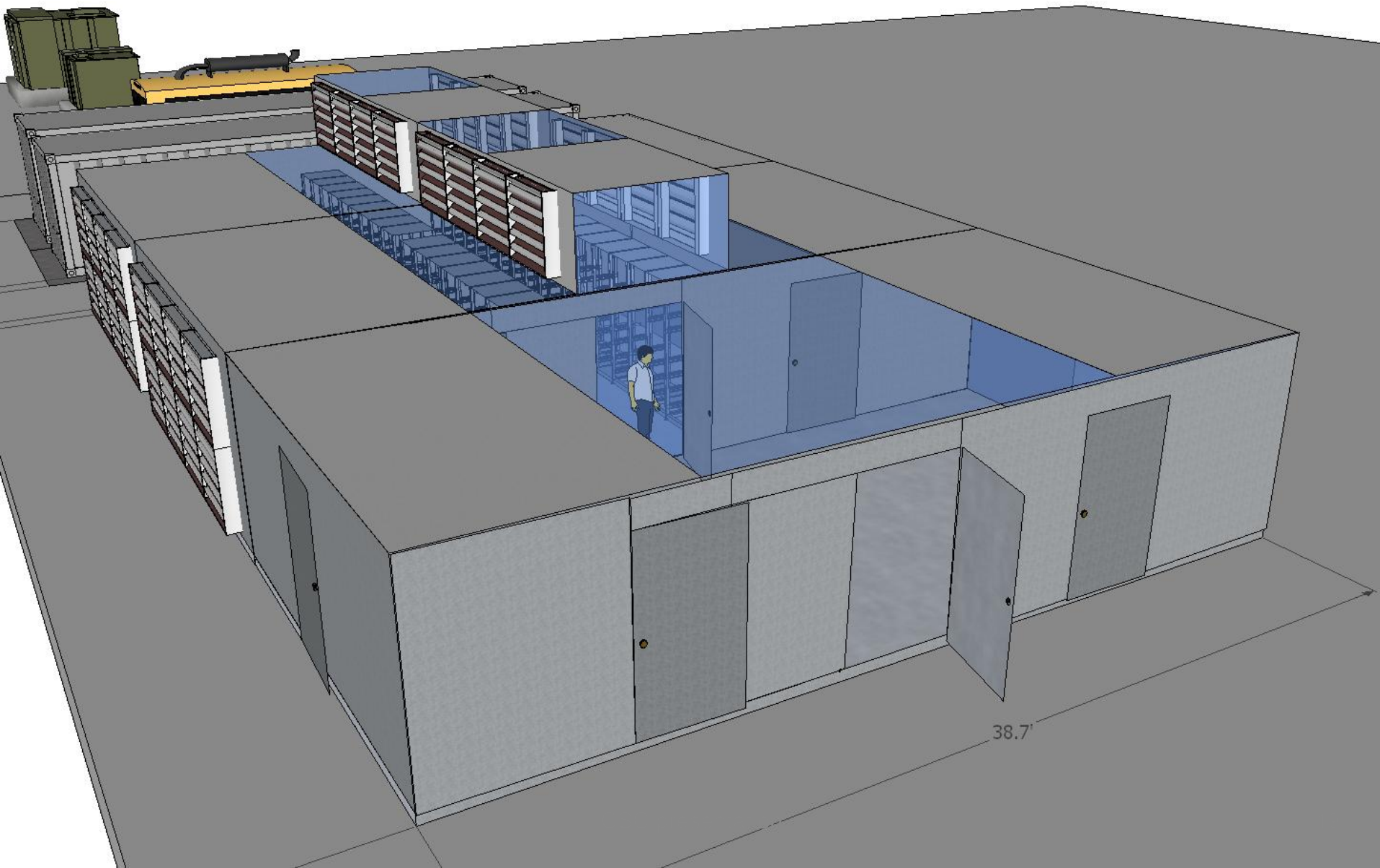

# SGL Ice Cube R80





# Data center specification



- 2.4 MW combined hybrid capacity
- 1.4 MW modular free air cooled datacenter
  - Upgradable in 700 kW factory built modules
  - Order to acceptance in 5 months
  - 35 kW per extra tall racks – 12 kW common in industry
  - PUE forecast < 1.08 ( $pPUE_{L2,YC}$ )
- 1MW HPC datacenter
  - Optimised for Cray super & T-Platforms prototype
  - 90% Water cooling

# CSC NEW SUPERCOMPUTERS

# Overview of New Systems



	Phase 1		Phase 2	
	Cray	HP	Cray	HP
<b>Deployment</b>	Done	Done	Probably 2014	
<b>CPU</b>	Intel Sandy Bridge 16 cores @ 2.6 GHz		Next generation processors	
<b>Interconnect</b>	Aries	FDR InfiniBand (56 Gbps)	Aries	EDR InfiniBand (100 Gbps)
<b>Cores</b>	11776	9216	~40000	~17000
<b>Tflops</b>	244 (2x Louhi)	180 (5x Vuori)	1700 (16x Louhi)	515 (15x Vuori)
<b>Tflops total</b>	424 (3.6x Louhi)		2215 (20.7x Louhi)	



# IT summary



## CRAY

- Cray XC30 supercomputer (Sisu)
  - Fastest computer in Finland
  - Phase 1: 385 kW, 244 Tflop/s, 16 x 2 GB cores per computing node, 4 x 256 GB login nodes
  - Phase 2: ~1700 Tflop/s
  - Very high density, large racks

# IT summary cont.



## ➤ HP (Taito)

- 1152 Intel CPUs
  - 16 x 4 GB cores per node
  - 16 fat nodes with 16 x16 GB cores per node
  - 6 x 64 GB login nodes
- 180 TFlop/s
- 30 kW 47 U racks



**DataDirect**<sup>™</sup>  
N E T W O R K S

## ➤ HPC storage

- 1 + 1.4 + 1.4 PB of fast parallel storage
- Supports Cray and HP systems

# Features



## ➤ Cray XC30

- Completely new system design
  - Departure from the XT\* design (2004)
- First Cray with Intel CPUs
- High-density water-cooled chassis
  - ~1200 cores/chassis
- New "Aries" interconnect



## ➤ HP Cluster

- Modular SL-series systems
- Mellanox FDR (56 Gbps) Interconnect



# CSC new systems: What's new?



## ➤ Sandy Bridge CPUs

- 4->8 cores/socket
- ~2.3x Louhi flops/socket
  - 256-bit SIMD instructions (AVX)

## ➤ Interconnects

- Performance improvements
  - Latency, bandwidth, collectives
  - One-sided communication

## – New topologies

- Cray: "Dragonfly": Islands of 2D Meshes
- HP: Islands of fat trees

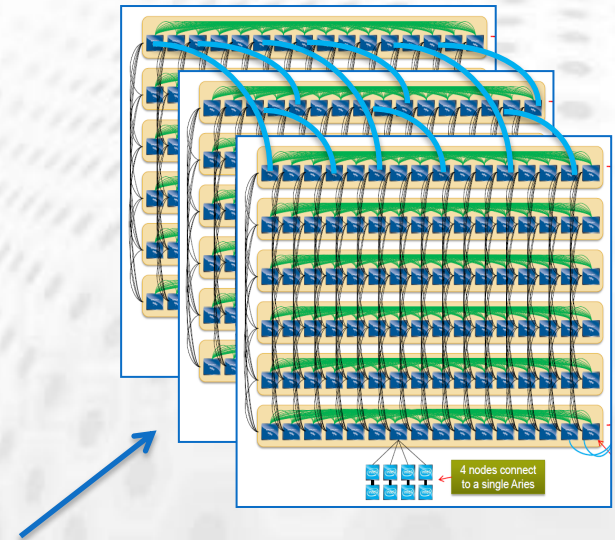

# Cray Dragonfly Topology

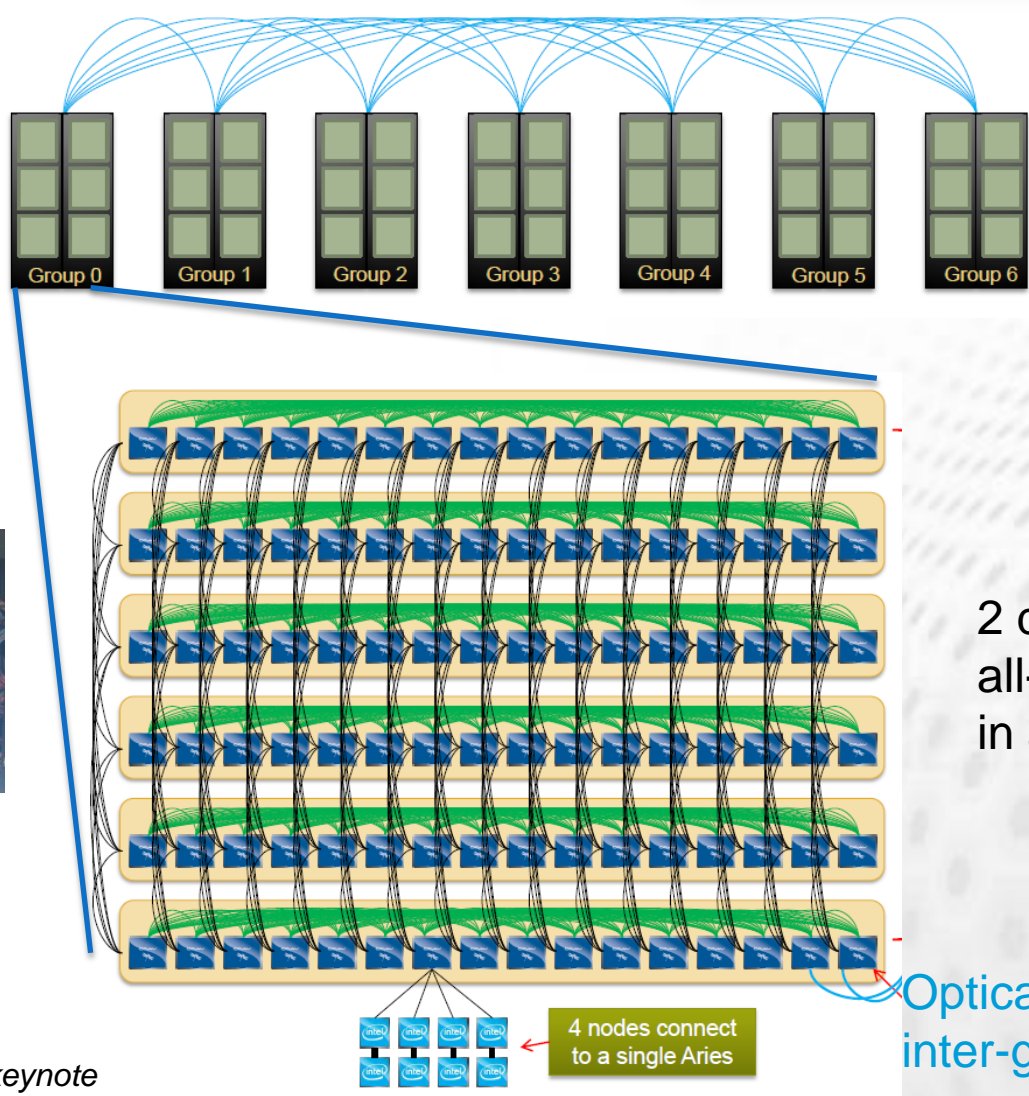

All-to-all network between groups

2 dimensional all-to-all network in a group

Optical uplinks to inter-group net

CSC presentation

Source:  
Robert Alverson, Cray  
Hot Interconnects 2012 keynote

# Cray environment

- Typical Cray environment
- Compilers: **Cray**, Intel and GNU
- Cray mpi, Cray tuned versions of all usual libraries
- SLURM
- Module system similar to Louhi
- Default shell: **bash** (previously tcsh)
- Character encoding: UTF-8
  - Latin-15 *alias* iso8859-15 currently on Louhi, Vuori and Hippu will be kept as is

# HP Environment

- Compilers: **Intel**, GNU
- MPI libraries: Intel, mvapich2, OpenMPI
- Batch queue: SLURM
- New more robust module system
  - Only compatible modules shown with *module avail*
  - Use *module spider* to see all
- Disk system changes
- Default shell: ***bash*** (used to be tcsh)
- Character encoding: UTF-8

# Core development tools



## ➤ Intel XE Development Tools

- Compilers
  - C/C++ (icc), Fortran (ifort), Cilk+
- Profilers and trace utilities
  - Vtune, Thread checker, MPI checker
- MKL numerical library
- Intel MPI library (only on HP)

## ➤ Cray Application Development Environment

## ➤ GNU Compiler Collection

## ➤ Tokens shared between HP and Cray

## ➤ TotalView debugger



# Performance of numerical libraries



## DGEMM 1000x1000 Single-Core Performance

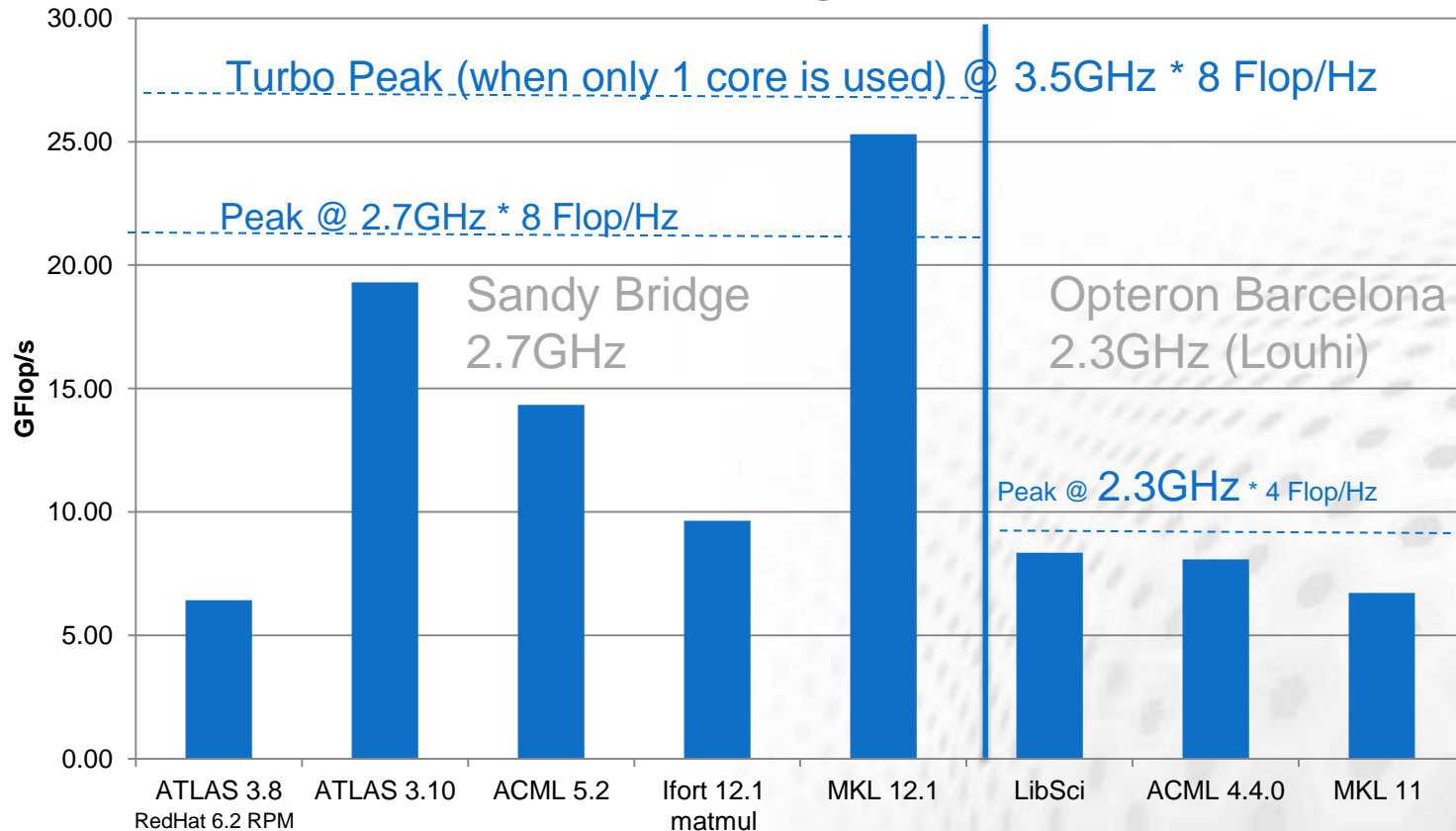

**MKL the best choice on Sandy Bridge, for now.**  
**(On Cray, LibSci will likely be a good alternative)**

# Compilers, programming



- Intel
  - Intel Cluster Studio XE 2013
  - <http://software.intel.com/en-us/intel-cluster-studio-xe>
- GNU
  - GNU-compilers, e.g. GCC 4.7.2.
  - <http://gcc.gnu.org/>
- Intel can be used together with GNU
  - E.g. gcc or gfortran + MKL + IntelMPI
- mvapich2 MPI-library also supported
  - It can be used that Intel or GNU

# Available applications

- Biggest ready
  - Taito: Gromacs, NAMD, Gaussian, Turbomole, Amber, CP2K, Elmer, VASP
  - Sisu: Gromacs, GPAW, Elmer, VASP
- CSC offers ~240 scientific applications
  - Porting them all is a big task
  - Most if not all (from Vuori) should be available
    - Some installations upon request
  - Do you have priorities?

# Porting strategy



- ➊ At least recompile
  - Legacy binaries may run, but not optimally
  - Intel compilers preferred for performance
  - Use Intel MKL or Cray LibSci (not ACML!)
    - ➋ <http://software.intel.com/sites/products/mkl/>
  - Use compiler flags (i.e. `-xhost -O2` (includes `-xAVX`))
- ➌ Explore optimal thread/task placement
  - Intra-node and internode
- ➍ Refactor the code if necessary
  - OpenMP/MPI workload balance
  - Rewrite any SSE assembler or intrinsics
- ➎ HPC Advisory Council has best practices for many codes
  - [http://www.hpcadvisorycouncil.com/subgroups\\_hpc\\_works.php](http://www.hpcadvisorycouncil.com/subgroups_hpc_works.php)
- ➏ During (and after) pilot usage, share your makefiles and optimization experiences in the wiki

# Modules

- ➊ Some software installations are conflicting with each other
  - For example different versions of programs and libraries
- ➋ Modules facilitate the installation of conflicting packages to a single system
  - User can select the desired environment and tools using module commands
  - Can also be done "on-the-fly"

## Key differences (Taito vs. Vuori)

- **module avail** shows only those modules that can be loaded to current setup (no conflicts or extra dependencies)
  - Use **module spider** to list all installed modules and solve the conflicts/dependencies
- **No PrgEnv- modules (*on Taito*)**
  - Changing the compiler module switches also MPI and other compiler specific modules

# Disks at Espoo

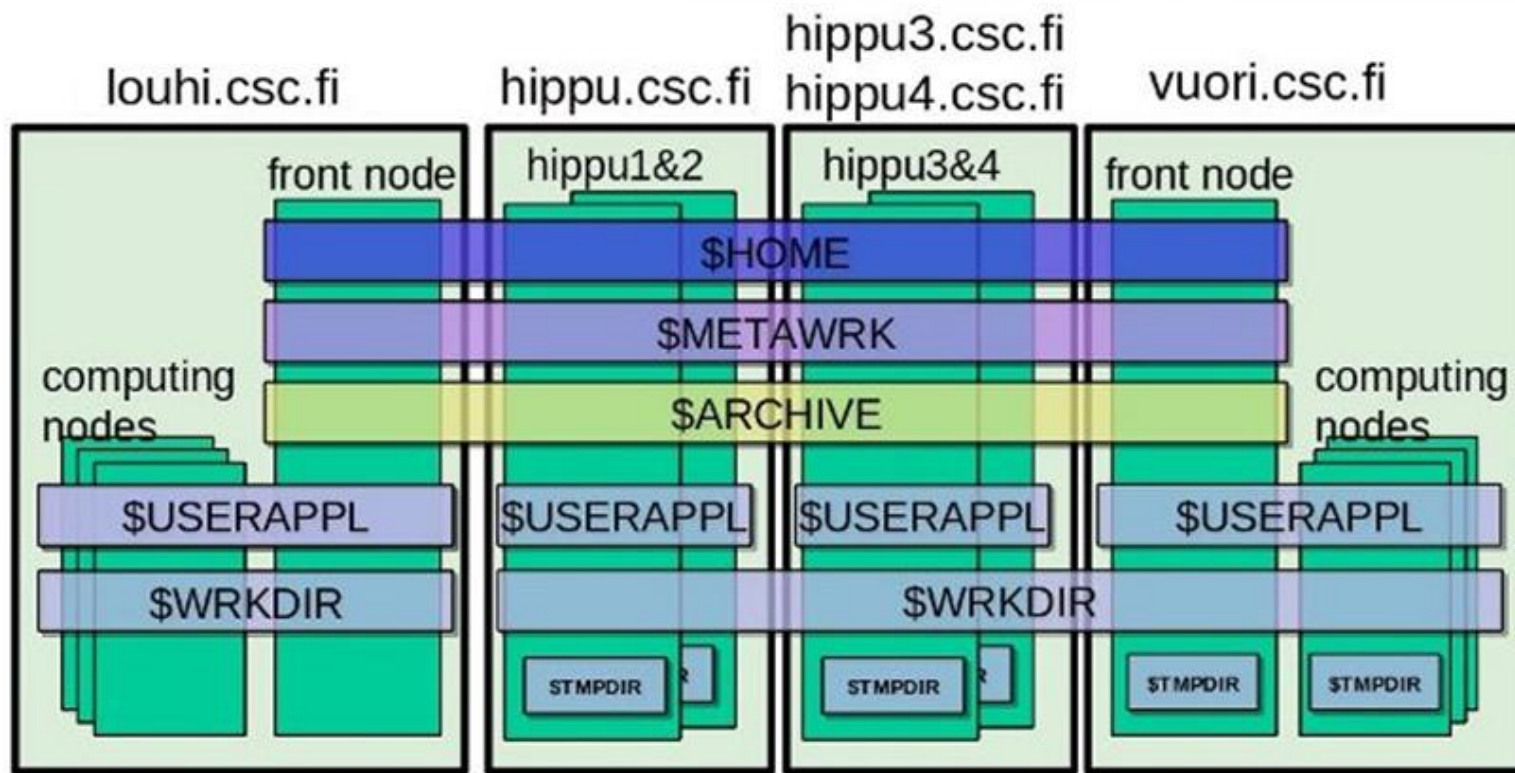

Existing gear in Espoo

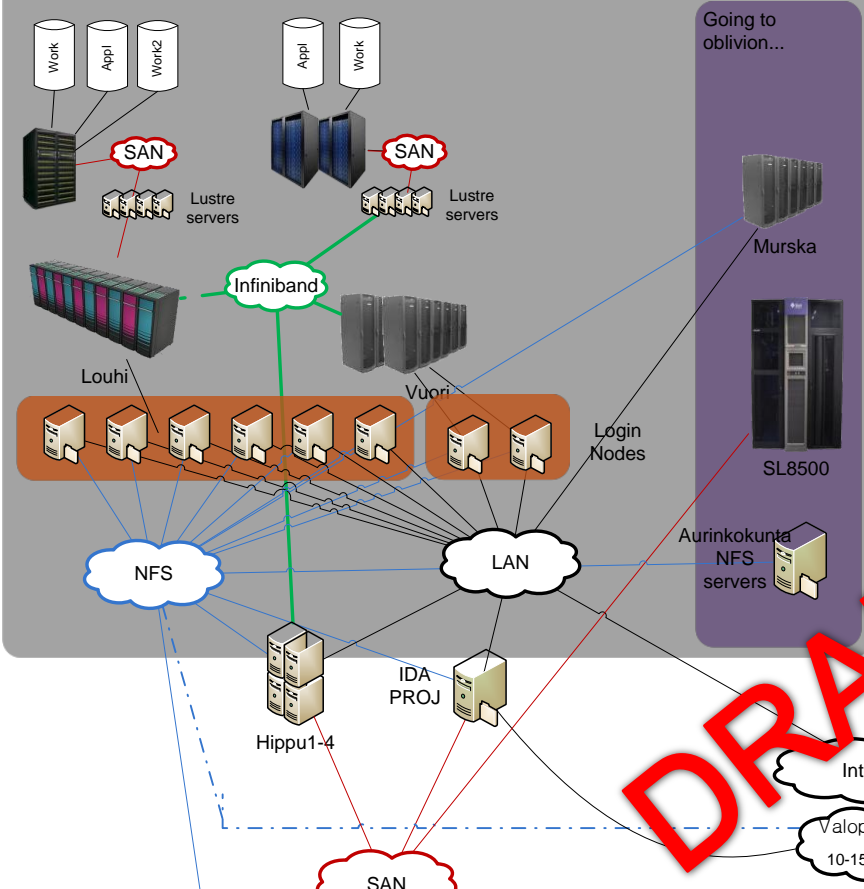

Kajjani

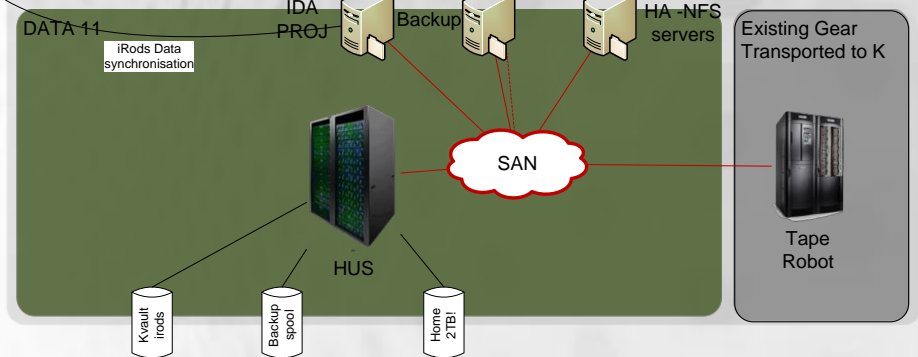
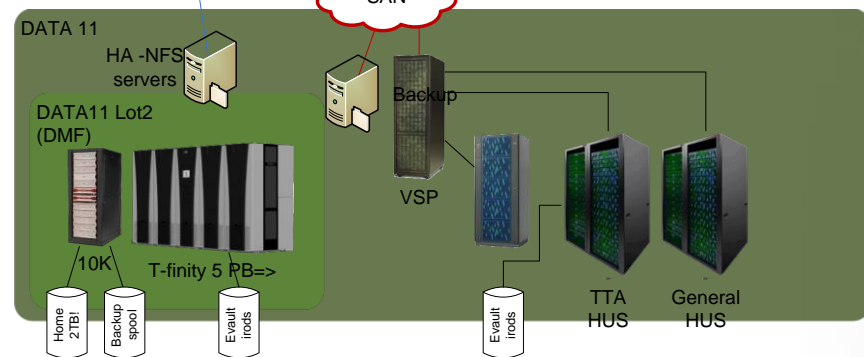
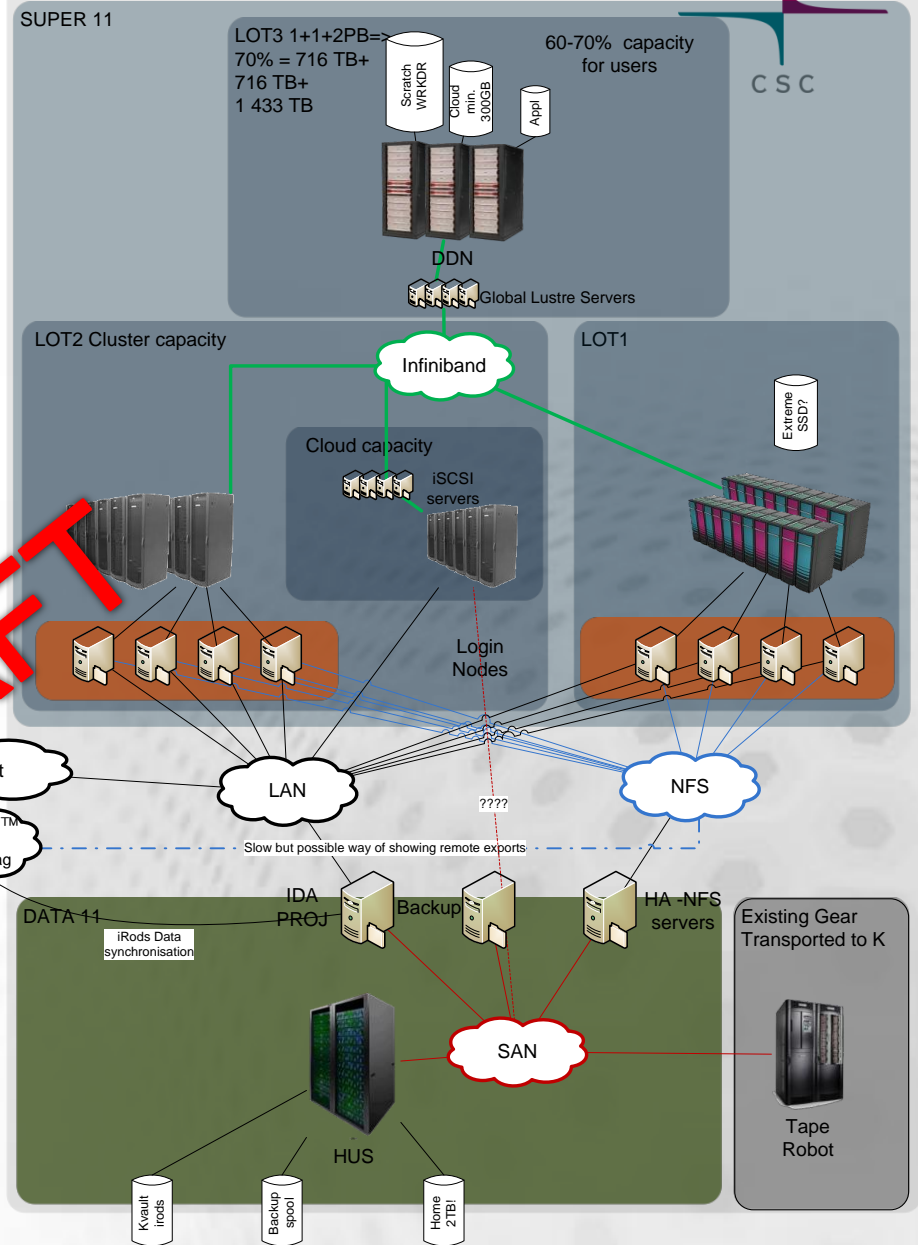



# Disks at Kajaani

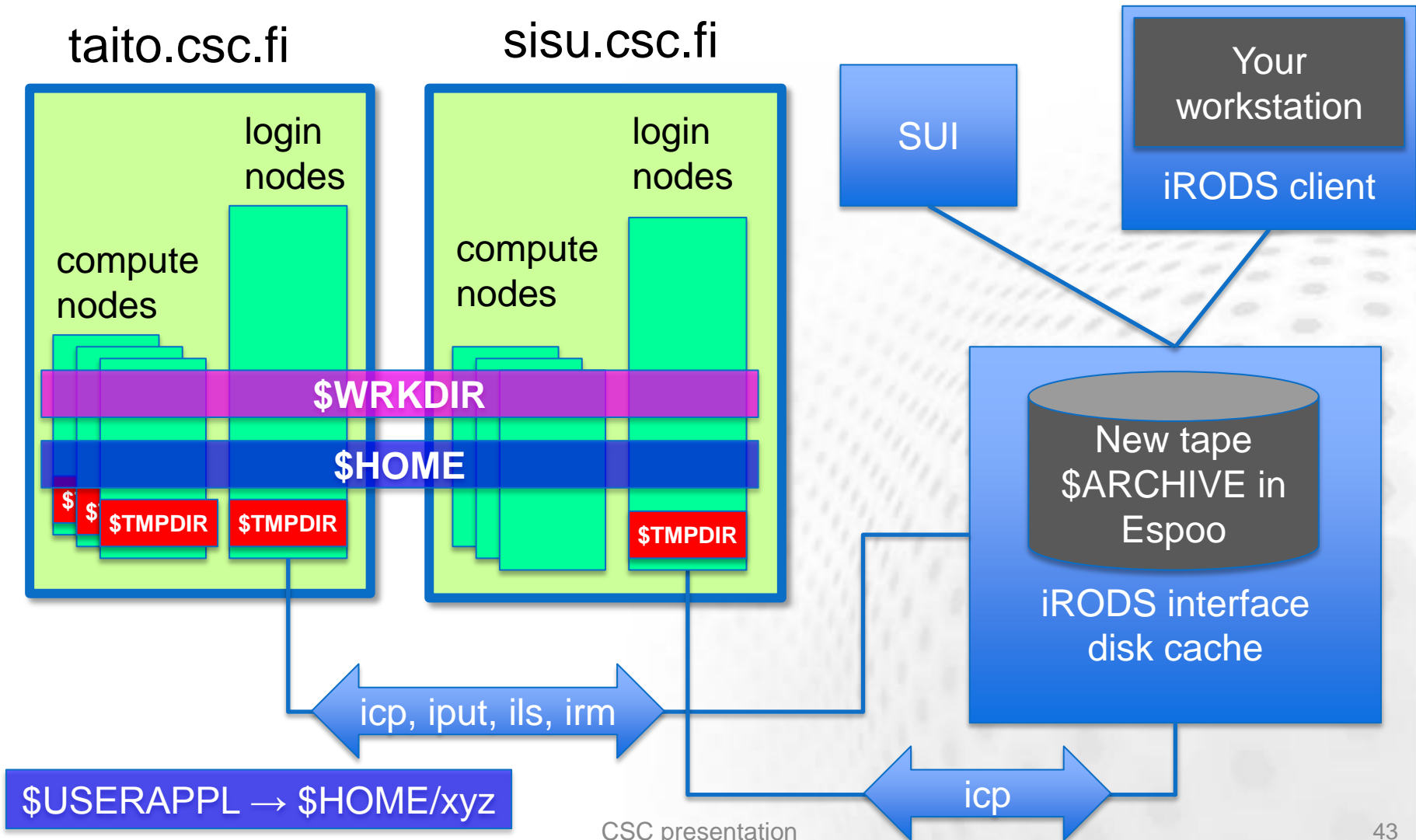

- 3.8 PB on DDN
  - New \$HOME directory (on Lustre)
  - \$WRKDIR (not backed up), soft quota ~ 5 TB
- \$ARCHIVE ~1 - 5 TB / user, common between Cray and HP
- Disk space through IDA
  - 1 PB for Universities
  - 1 PB for Finnish Academy (SA)
  - 1 PB to be shared between SA and ESFRI
  - more could be requested
- /tmp (around 1.8 TB) to be used for *compiling codes*

# IDA service promise



- The IDA service guarantees data storage till at least end of year 2017. By that timeline it will be decided if IDA or some other service solution (for example Long Term Storage solution) continues to serve as data storage. If some other solution is available, the data will be automatically transferred to this service, no interaction needed from users.
- **The IDA service guarantees at least 3 petabytes storage capacity.**
- When transferring data to IDA, some metadata will automatically be attached to the data.
- During this time period, there are no costs to the user within agreed service policy.
- Owners of data can decide on data use, openness and data policy.
- TTA strongly recommends clear ownership and IPR management for all datasets
- After 2017, metadata attached to datasets has to be more extensive than minimum metadata.

# Datasets served by TTA

- Projects funded by Finnish Academy (akatemiahankeet, huippuyksiköt, tutkimusohjelmat and tutkimusinfrastruktuurit)
  - 1 PT capacity
- Universities and Polytechnics
  - 1 PT capacity
- ESFRI-projects (tex. BBMRI, CLARIN)
- Other important research projects via special application process

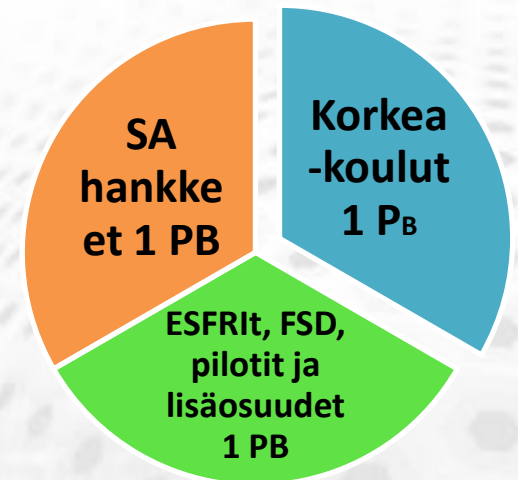

← → S + csc.fi <https://sui.csc.fi/group/sui/my-files>



CSC – IT Center for Science

Scientist's User Interface

[Home](#)

[Services](#)

[Contact](#)

[SUI](#)

[Services](#)

My Files

My Files



<https://sui.csc.fi/my-files/ida/ida/jdoe/test>

My Places

▶  hippu

▶  louhi

▶  vuori

▼  ida

▼  ida

▼  jdoe

▼  test

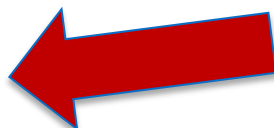

4GB

application/octet-stream

3.73 GB



DMF-007-3681-011.pdf

application/pdf

885.72 kB

# Moving files, best practices



- tar & bzip first
- rsync, not scp
  - `rsync -P username@hippu1.csc.fi:/tmp/huge.tar.gz .`
- Blowfish may be faster than AES (CPU bottleneck)
- Funet FileSender (max 50 GB)
  - <https://filesender.funet.fi>
  - Files can be downloaded also with wget
- Consider: SUI, IDA, iRODS, batch-like process, staging
- CSC can help to tune e.g. TCP/IP parameters
  - <http://www.csc.fi/english/institutions/funet/networkservices/pert>
- FUNET backbone 10 Gbit/s

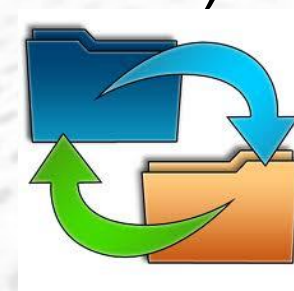

# ARCHIVE, dos and don'ts



- Don't put small files in \$ARCHIVE
  - Small files waste capacity
  - Less than 10 MB is small
  - Keep the number of files small
  - Tar and bzip files
- Don't use \$ARCHIVE for incremental backup (store, delete/overwrite, store, ...)
  - Space on tape is not freed up until months or years!
- Maximum file size 300GB
- Default quota 2 TB per user, new likely up to 5 TB
- New ARCHIVE being installed, consider if you really need all your old files. *Transfer from old to new needed.*



## Use profiles

- Taito (HP)
- Serial and parallel upto about 256 cores (TBD)
- Sisu (Cray XE30)
- Parallel up to thousands of cores
- Scaling tests



# Queue/server policies

- Longrun queue has drawbacks
  - Shorter jobs can be chained
- Apps that can't restart/write checkpoint?
  - Code you use to run very long jobs?
- Large memory jobs to Hippu/HP big memory nodes
  - Think about memory consumption
- Minimum job size in Cray

# Documentation and support



- User manual being built, FAQ here:
  - <https://datakeskus.csc.fi/en/web/guest/faq-knowledge-base>
  - Pilot usage during acceptance tests
- User documentation's link collection
  - <http://www.csc.fi/english/research/sciences/chemistry/intro>
- Porting project
  - All code needs to be recompiled
  - Help available for porting your code
- List of first codes, others added later, some upon request
- User accounts
  - [HP: recent Vuori users moved automatically](#)
  - [Cray: recent Louhi users moved automatically](#)
  - Others: request from [usermgr@csc.fi](mailto:usermgr@csc.fi) with *current* contact information

# Grand Challenges

- **Normal GC** (*in half a year*)
  - new CSC resources available for a year
  - no bottom limit for number of cores
- **Special GC call** (mainly for Cray) (*based on your needs*)
  - possibility for short (day or less) runs with the whole Cray
- **Remember also PRACE/DECI**
  - <http://www.csc.fi/english/csc/news/customerinfo/DECI10callopen>

# Accelerators



- Add-on processors
- Graphics Processing Units
  - *de facto* accelerator technology today
- Many lightweight cores
- Influencing general purpose computing

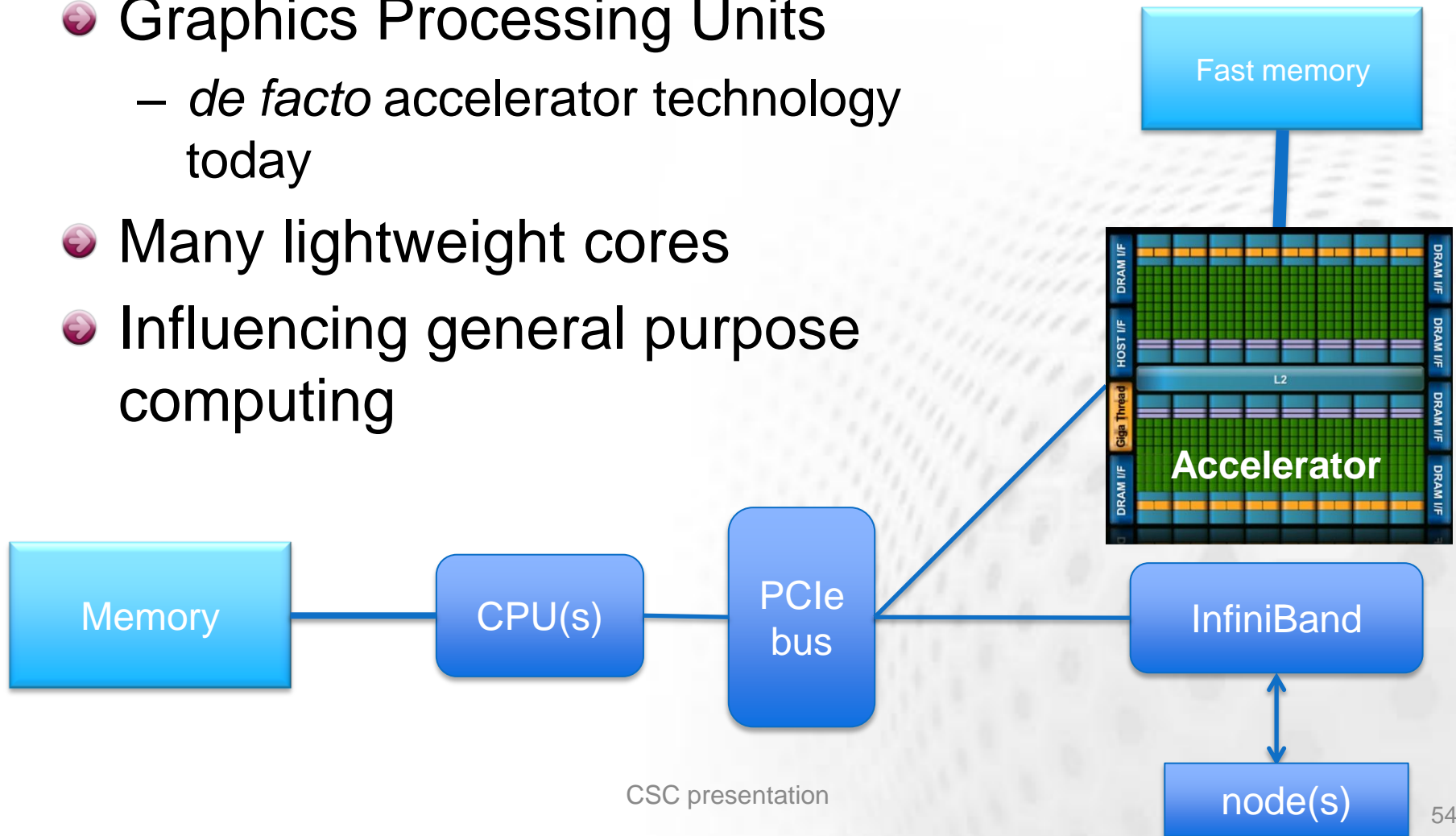

# Evolution of CPU and GPU performance

## Memory bandwidth

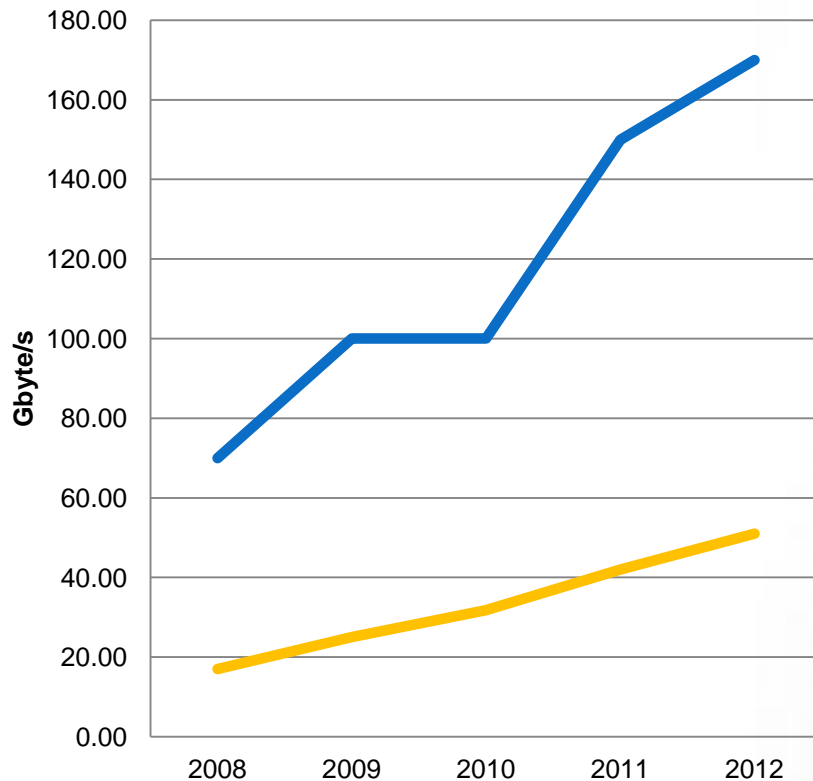

## Energy efficiency

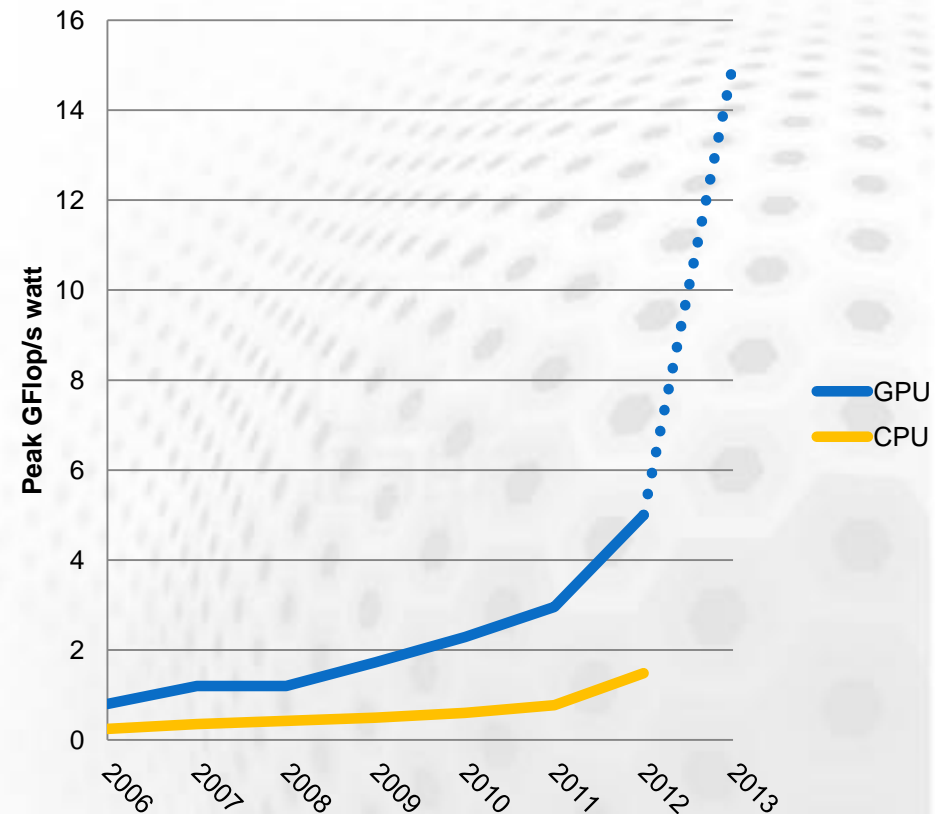

# Future directions in parallel programming

- **MPI-3** standard being finalized
  - Asynchronous collective communication etc.
- **Partitioned Global Address Space (PGAS)**
  - Data sharing via global arrays
  - Finally starting to see decent performance
  - Most mature: **Unified Parallel C, Co-Array Fortran** (in Fortran 2008), **OpenSHMEM**
- **Task Dataflow -based parallel models**
  - Splits work into a graph (DAG) of tasks
  - **SmpSs, DAGUE, StarPU**

# CSC RESOURCES AVAILABLE FOR RESEARCHERS

# Currently available computing resources

CSC

- ➊ Massive computational challenges: Sisu (Louhi being decommissioned)
  - > 10 000 cores, >23TB memory
  - Theoretical peak performance > 240 Tflop/s
- ➋ HP-cluster Taito (Vuori by the end 2013)
  - Small and medium-sized tasks
  - Theoretical peak performance 180 Tflop/s (40)
- ➌ Application server Hippu
  - Interactive usage, without job scheduler
  - Postprocessing, e.g. visualization



➍ FGI



- Production (available for all Finnish researchers)
  - **Vuori**: 8 Tesla GPU nodes
  - **FGI**: 88 GPUs (44 Tesla 2050 + 44 Tesla 2090)
    - GPU nodes located at **HY, Aalto, ÅA, TTY**
- Testing
  - **Mictest**: Intel MIC nodes
    - Several cards
  - **Tunturi**: Sandy Bridge node, cluster (*for CSC experts*)
    - Porting to AVX instruction set

# Old capacity decommissions



- Louhi to be decommissioned
  - guaranteed access likely by May 1, 2013
  - *communicated via Louhi's MOTD (message of the day), louhi-users mailing list, customer bulletin*
- Vuori decommission by the end of 2013

# CSC cloud services

# Three service models of cloud computing

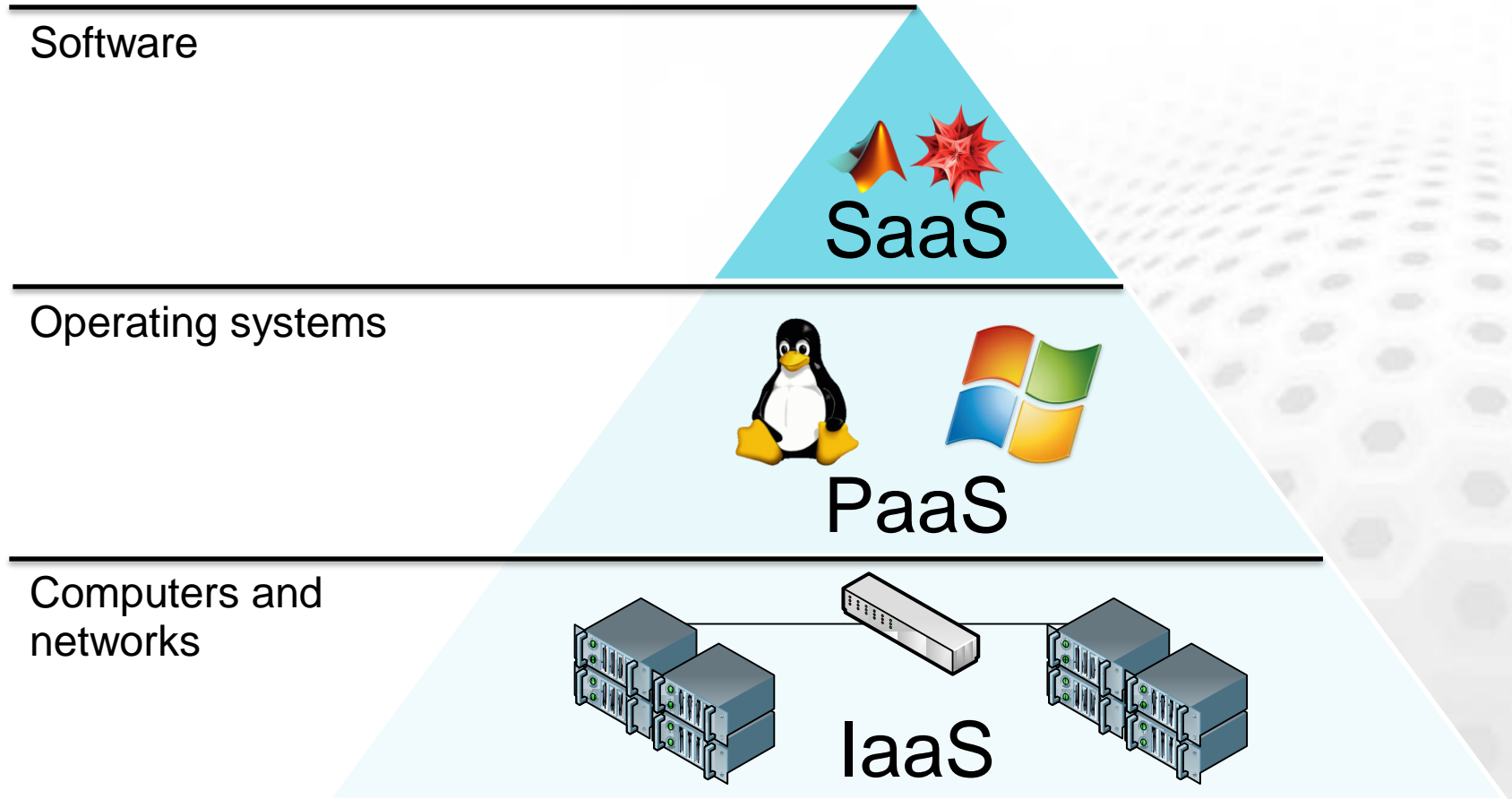

# Example: Virtualization in Taito



Taito cluster:

two types of nodes, HPC and cloud

HPC  
node

HPC  
node

Cloud  
node

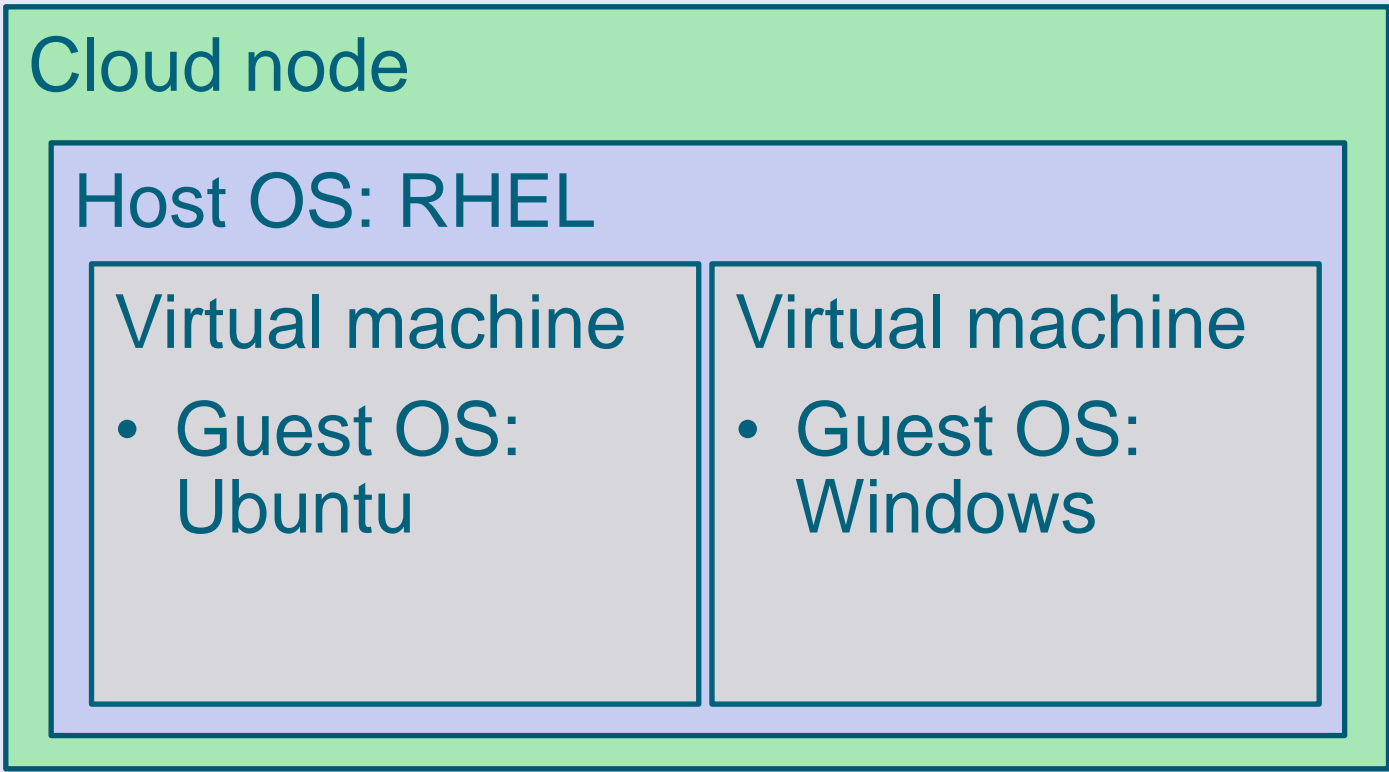

# Traditional HPC vs. IaaS



	Traditional HPC environment	Cloud environment Virtual Machine
Operating system	Same for all: CSC's cluster OS	Chosen by the user
Software installation	Done by cluster administrators Customers can only install software to their own directories, no administrative rights	Installed by the user The user has admin rights
User accounts	Managed by CSC's user administrator	Managed by the user
Security e.g. software patches	CSC administrators manage the common software and the OS	User has more responsibility: e.g. patching of running machines
Running jobs	Jobs need to be sent via the cluster's Batch Scheduling System (BSS)	The user is free to use or not use a BSS
Environment changes	Changes to SW (libraries, compilers) happen.	The user can decide on versions.
Snapshot of the environment	Not possible	Can save as a Virtual Machine image
Performance	Performs well for a variety of tasks	Very small virtualization overhead for most tasks, heavily I/O bound and MPI tasks affected more

## Cloud: Biomedical pilot cases

- Several pilots (~15)
- Users from several institutions, e.g.  
University of Helsinki, Finnish Institute for  
Molecular Medicine and Technical  
University of Munich
- Many different usage models, e.g.:
  - Extending existing cluster
  - Services run on CSC IaaS by university IT  
department for end users (SaaS for end users)

# NX for remote access

- Optimized remote desktop access
  - Near local speed application responsiveness over high latency, low bandwidth links
- Customized launch menus offer direct access CSC supported applications
- Working session can saved and restored at the next login
- Further information:  
*<http://www.csc.fi/english/research/software/freenx>*



# NX screenshot



Terminal window title: NX - @nxlogin.csc.fi:1012 - nxlogin3 (GPL Edition)

Terminal window title: ssh

ParaView 3.14.1

File Edit View

builtin:

- Sphere
- Cylinde
- Cone1

Properties Display Information

Display

View

- Visible Zoom To Data
- Selectable

Color

- Interpolate Scalars
- Map Scalars
- Apply Texture: None
- Color by: Solid Color
- Set Solid Color...

Slice

Slice Direction

VIM - Vi Improved

version 7.2.411  
by Bram Moolenaar et al.  
Modified by <bugzilla@redhat.com>  
Vim is open source and freely distributable

Help poor children in Uganda!  
type :help iccf<Enter> for information

type :q<Enter> to exit  
type :help<Enter> or <F1> for on-line help  
type :help version?<Enter> for version info

0,0-1 All

Time: 0

one ssh ParaView 3.14.1 64-bit ssh 16:57

# Customer training



- Taito (HP)
  - Taito cluster workshop in April 17 - 19
- Sisu (Cray)
  - *ongoing*: February 26 - March 1 (mostly for pilot users, open for everyone)
  - May 14 - 17 (for all users, a PATC course, i.e. expecting participants from other countries too)
  - December 2013 (likely) MIC programming
- CSC courses: <http://www.csc.fi/courses>
- CSC HPC Summer School; Spring, Winter Schools

# How to prepare for new systems



- Participate in system workshops
- Try Intel/GNU compiler in advance, PGI upon request
- Check if your scripts/aliases need fixing (***bash***)
- A lot of resources available in the beginning: prepare ahead what to run!
- The traditional wisdom about good application performance will still hold
  - Experiment with all compilers and pay attention on finding good compiler optimization flags
  - Employ tuned numerical libraries wherever possible
  - Experiment with settings of environment variable that control the MPI library
  - Mind the I/O: minimize output, checkpoint seldom

# Sisu&Taito vs. Louhi&Vuori vs. FGI vs. Local Cluster

	Sisu&Taito (Phase 1)	Louhi&Vuori	FGI	Merope
<b>Availability</b>	1Q/2Q 2013	Available	Available	Available
<b>CPU</b>	Intel Sandy Bridge, 2 x 8 cores, 2.6 GHz, Xeon E5-2670	AMD Opteron 2.3 GHz Barcelona and 2.7 GHz Shanghai / 2.6 GHz AMD Opteron and Intel Xeon	Intel Xeon, 2 x 6 cores, 2.7 GHz, X5650	
<b>Interconnect</b>	Aries / FDR IB	SeaStar2 / QDR IB	QDR IB	
<b>Cores</b>	11776 / 9216	10864 / 3648	7308	748
<b>RAM/core</b>	2 / 4 GB 16x 256GB/node	1 / 2 / 8 GB	2 / 4 / 8 GB	4 / 8 GB
<b>Tflops</b>	244 / 180	102 / 33	95	8
<b>GPU nodes</b>	in Phase2	- / 8	88	6
<b>Disc space</b>	2.4 PB	110 / 145 TB	1+ PB	100 TB <sup>50</sup>

# Conclusions



- Performance comparison
  - Per core performance  
~2 x compared to Vuori/Louhi
  - Better interconnects enhance scaling
  - Larger memory
  - Smartest collective communications
- The most powerful computer(s) in Finland

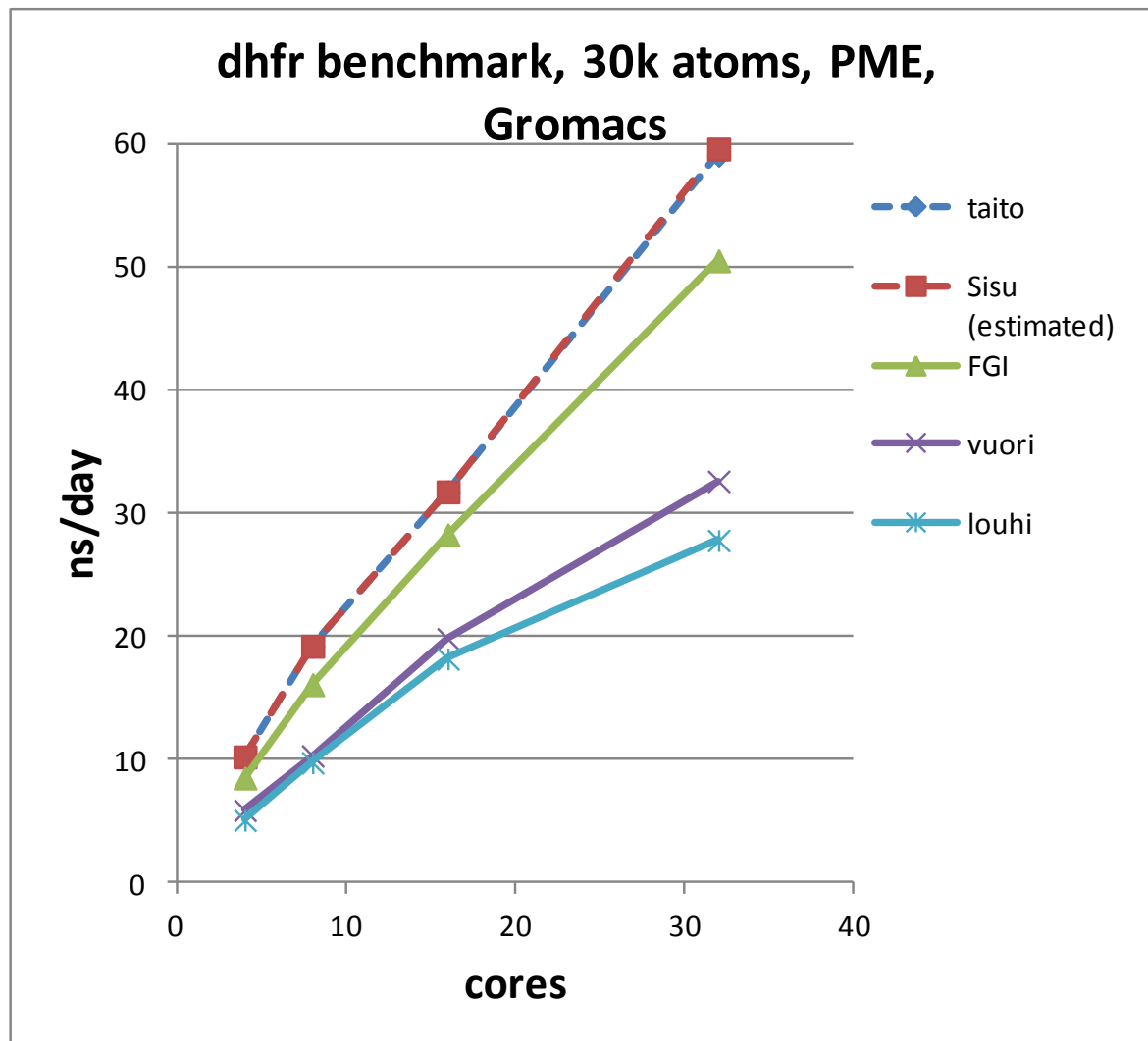

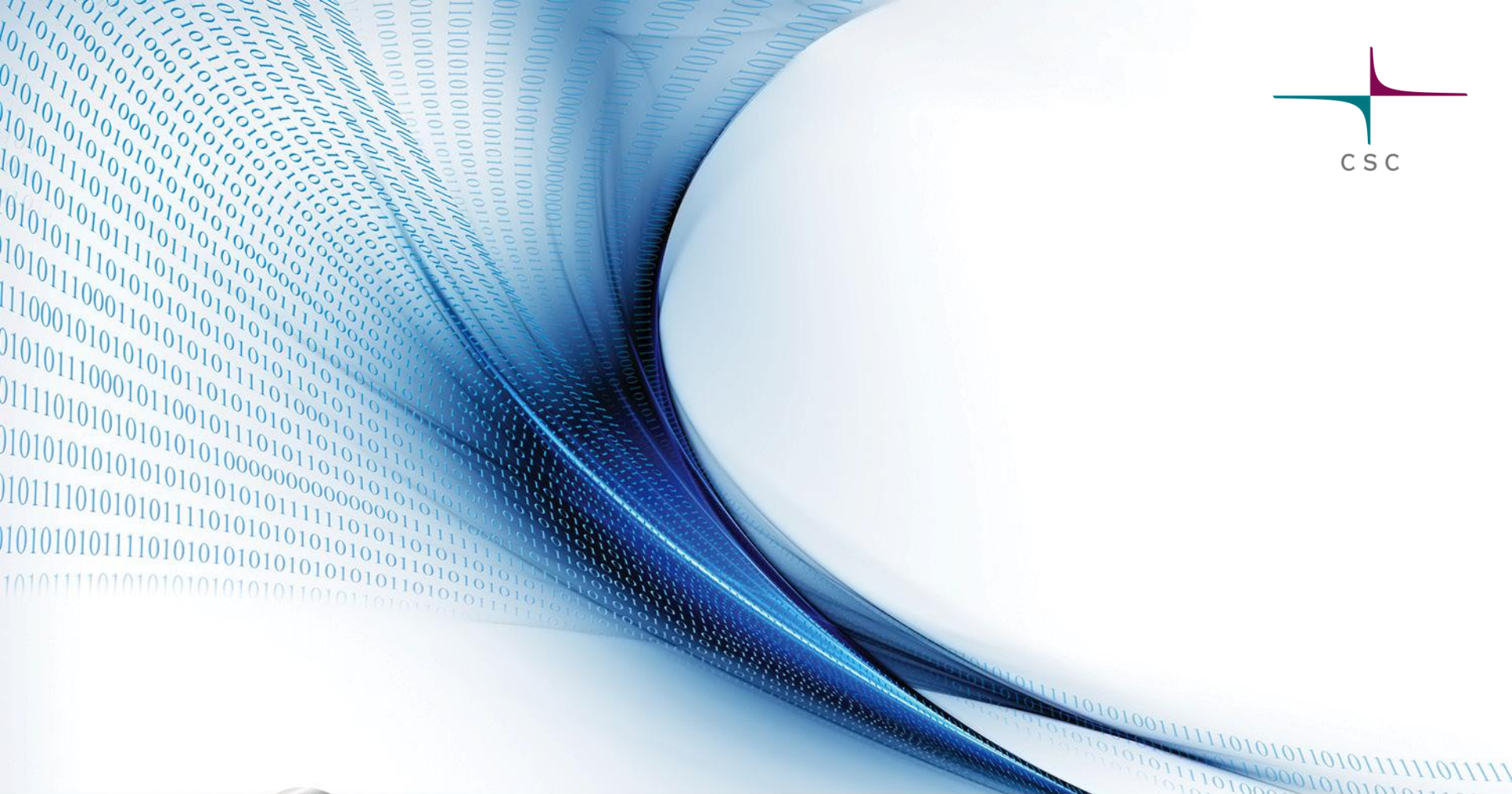

## Round robin

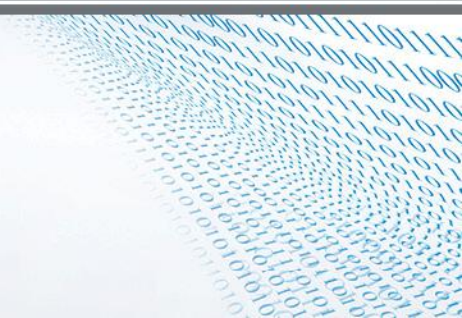

# Round robin



- HIP and CSC
- What are your research interest?
  - How CSC can help?
  - Special libraries/tools?
- Queue length: 3 days enough?
  - Codes that can't checkpoint?
- Is memory an issue for you?
  - 256 GB/nodes usage policy?
- Applying for Grand Challenge?
  - Special Grand Challenge?
- Need to move a lot of files? (from where?)
- Interested in GPGPU/MICs? Which code?